

Bucardo © M. S. Rojas Mayo-2002
 Sin pena

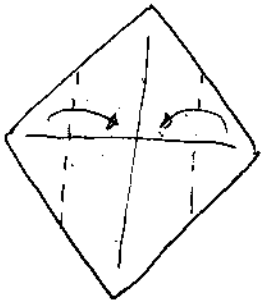

1.-

Marrón
 claro,
 Marrón
 oscuro

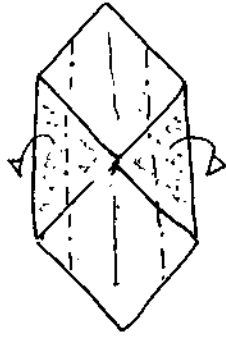

2.-

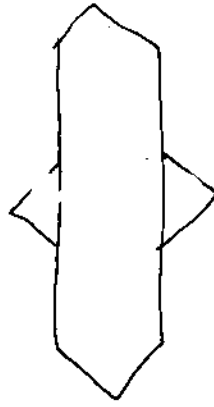

3.-

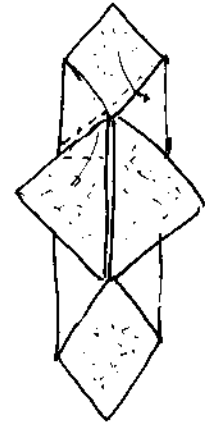

4.-

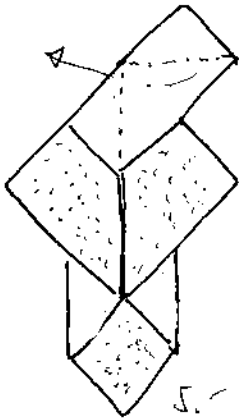

5.-

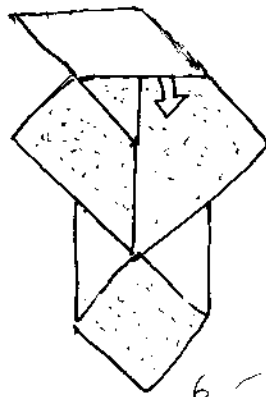

6.-

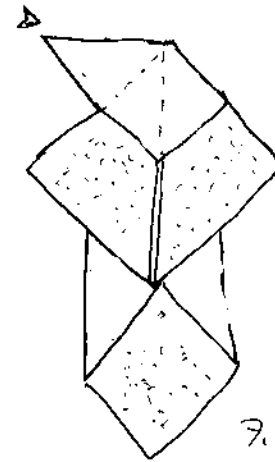

7.-

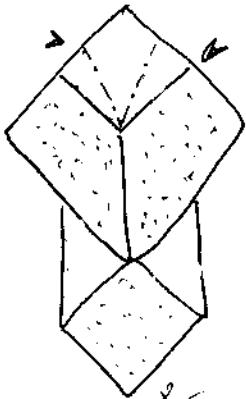

8.-

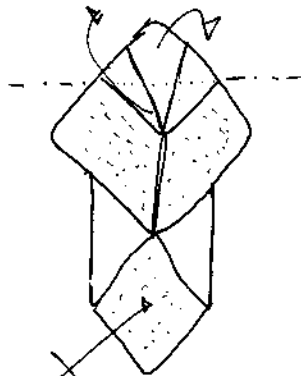

9.-

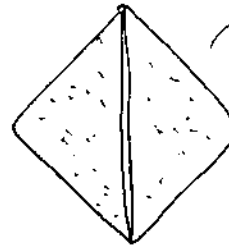

10.-

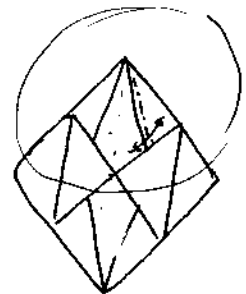

11.-

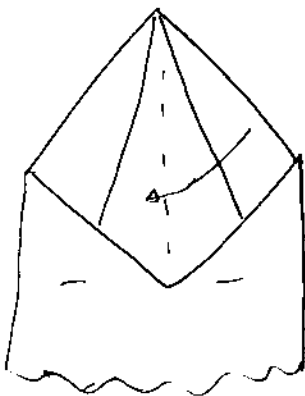

12.-

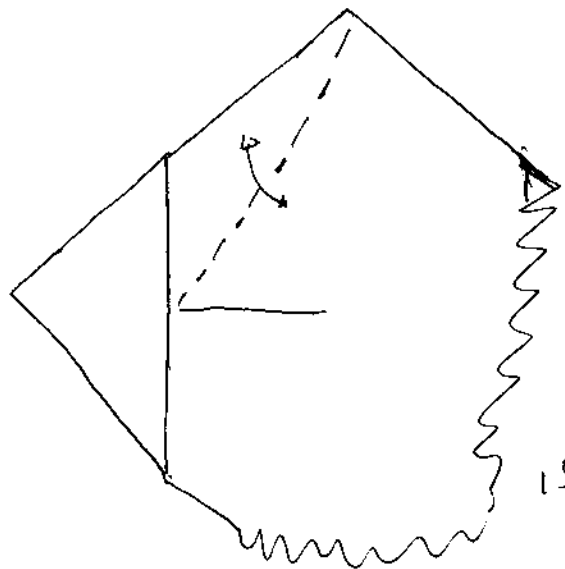

13

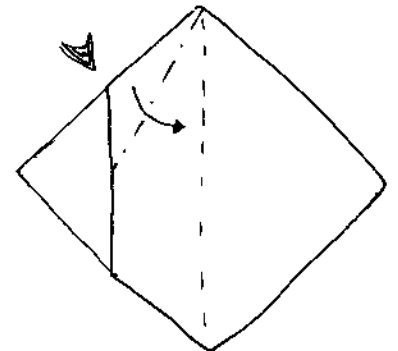

14

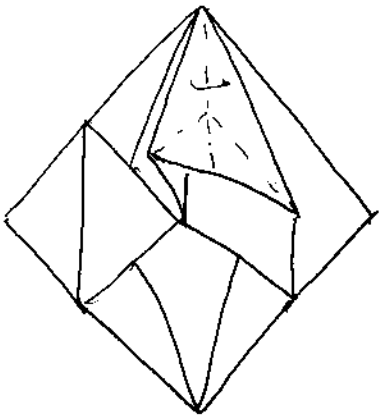

15.- No puede dejarse plano

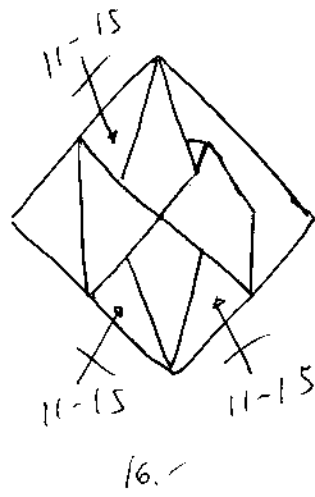

16.-

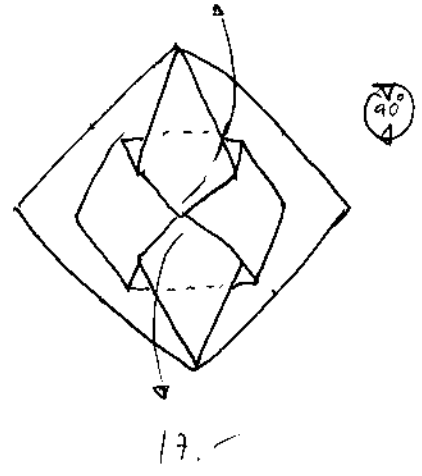

17.-

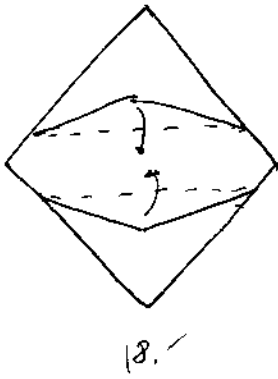

18.-

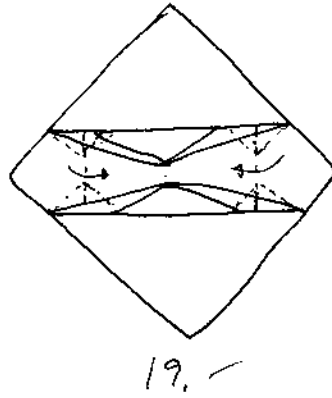

19.-

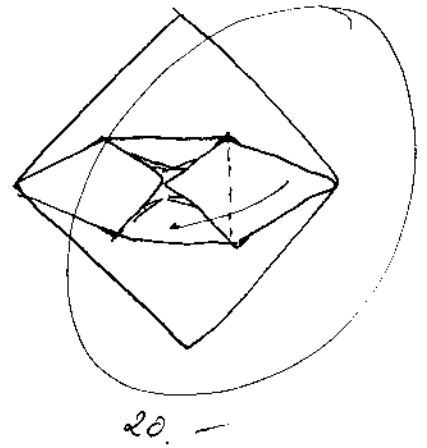

20.-

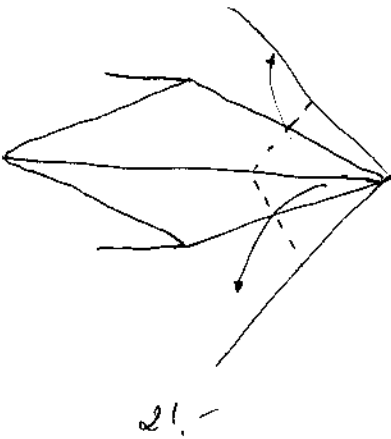

21.-

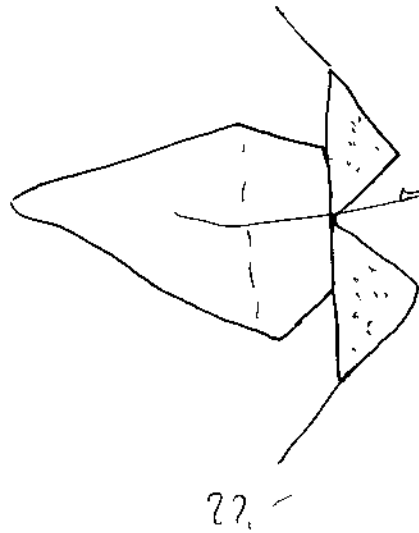

22.-

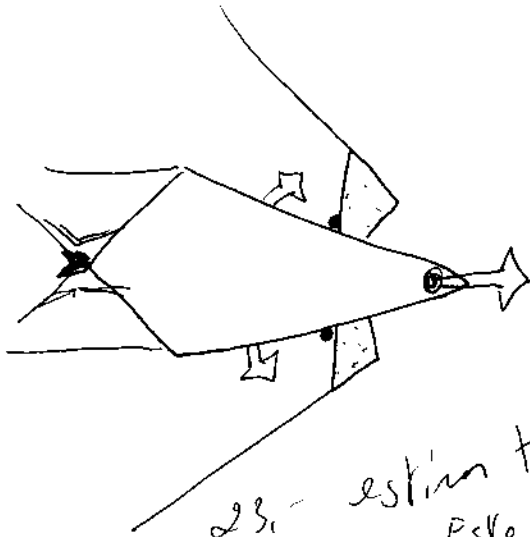

23.- están trapezoidalmente. Si se traza un punto que hace de base de esto es para los lados longitudinales. Los estimamientos usual de reducción

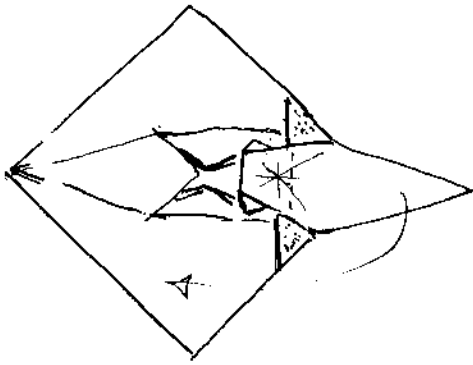

24.-

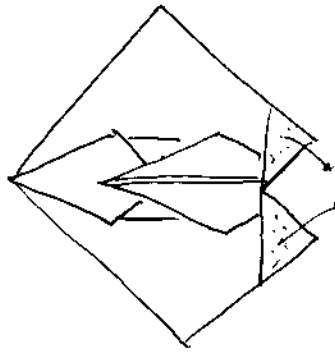

25.-

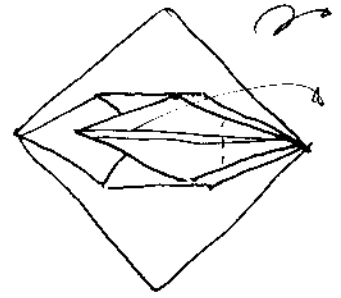

26.-

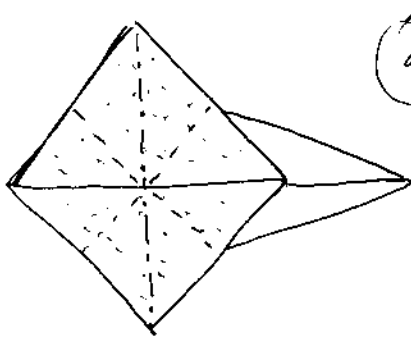

27.-

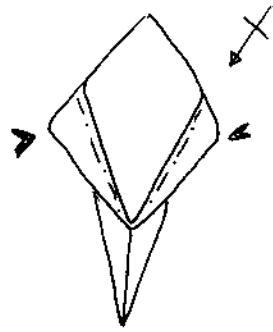

28.-



29.- Doblar todas las
capas y unir las
primera

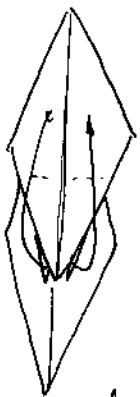

30
Unir dos picos de
cada lado

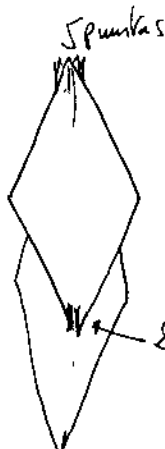

31

2 picos

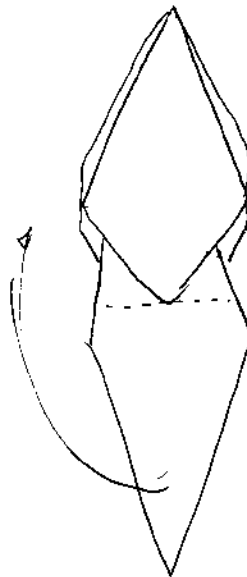

32.-



33.-

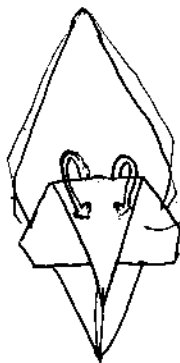

34.-

pasar al
interior superior



35.-

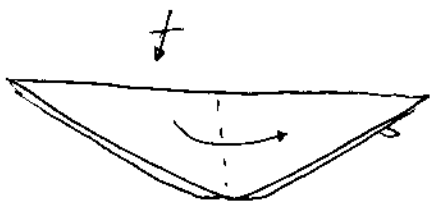

36.

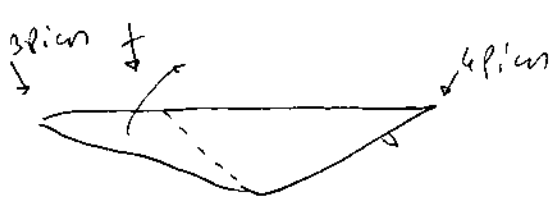

37.

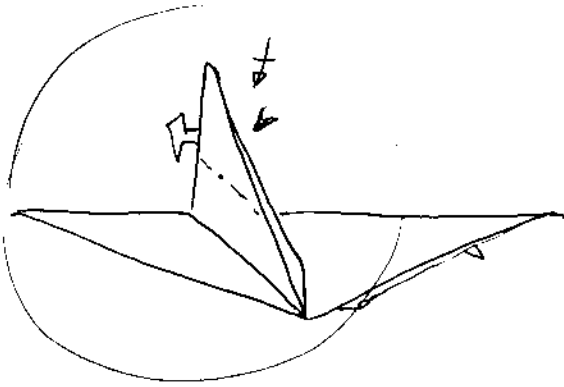

38

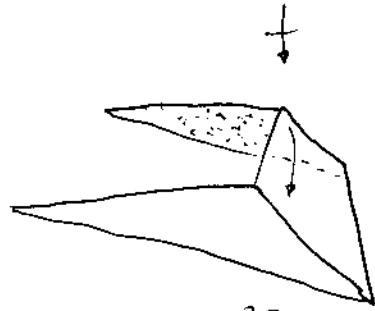

39

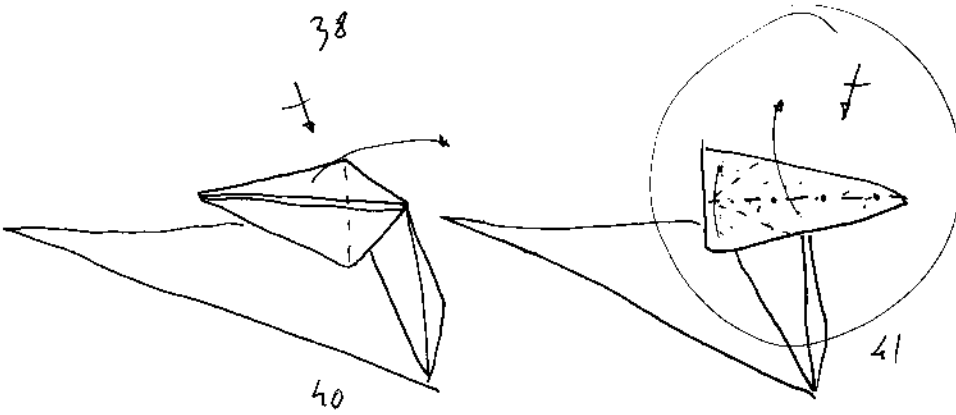

40

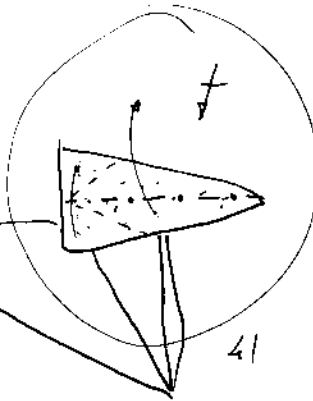

41



42



43

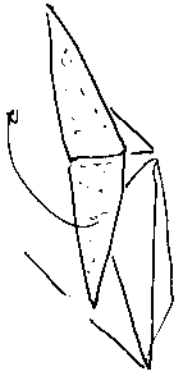

44



45



46

de hacer
de con
para dar
forma

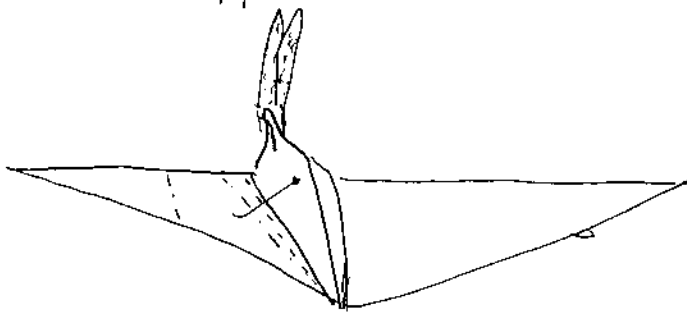

47.

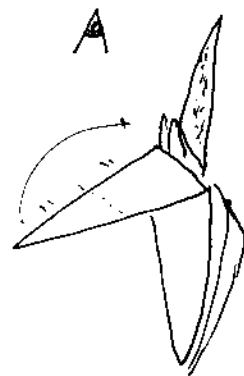

48.- Cambio de
vista

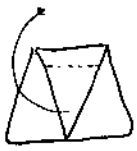

49.-



50.-



51.-



52.-

Cambio de vista

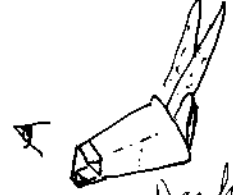

53.-

dar forma.
cambio de vista

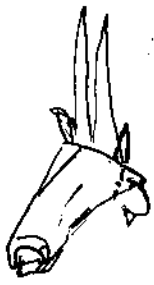

54.- Ya ves dibujar la cabeza hasta el final.

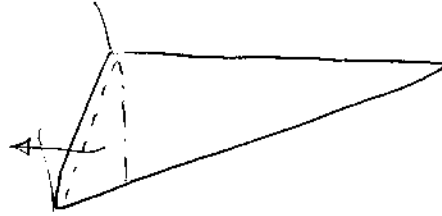

55. Manos delanteras

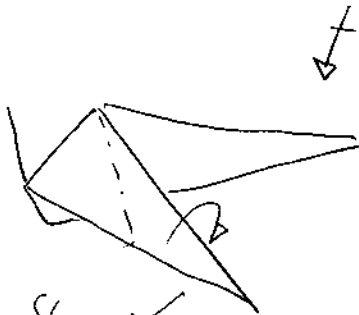

56

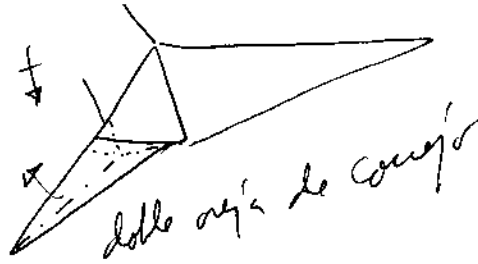

57

doble ojo de conejo

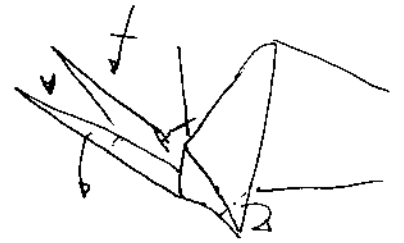

58.-

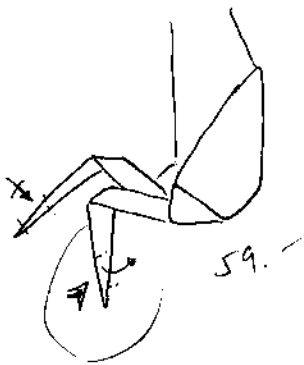

59.-

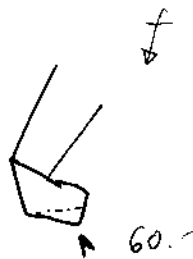

60.-



61.-

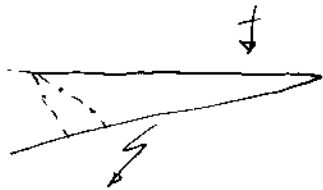

62.- traseros



63.-

